



Great Flexibility
at every turn

GF85



Great Flexibility at every turn

GF85

Introducing the new floor-mounted digital radiography system, GF85, designed with workflow efficiency in mind. Mirroring the innovative core technology of Samsung's premium DR line-up, it offers outstanding ease of use, reliable performance and durability.

01

STREAMLINE
WITHOUT COMPROMISE

02

DIAGNOSTIC
CONFIDENCE

03

EXPAND
PREMIUM EXPERIENCE

Samsung Premium DR Systems



GC85A Vision+



GM85



AccE Glass-Free
Detector



GF85



The all-new floor-mounted system is here.
It's ready to revolutionize your workflow.

* Optional feature requiring additional purchase
† Not available feature in the 4-way table

STREAMLINE WITHOUT COMPROMISE

Great Flexibility on a Small Footprint

Great Flexibility in Configuration

to meet versatile clinical and economic needs

Wall Stand	Patient Table	Collimator	Detector
<input checked="" type="checkbox"/> Non-tilting <input type="checkbox"/> Tiling	<input checked="" type="checkbox"/> 6-way Table <input type="checkbox"/> 4-way Table <input type="checkbox"/> No Table	<input checked="" type="checkbox"/> Motorized <input type="checkbox"/> Manual	Tube & HVG SW Application ...

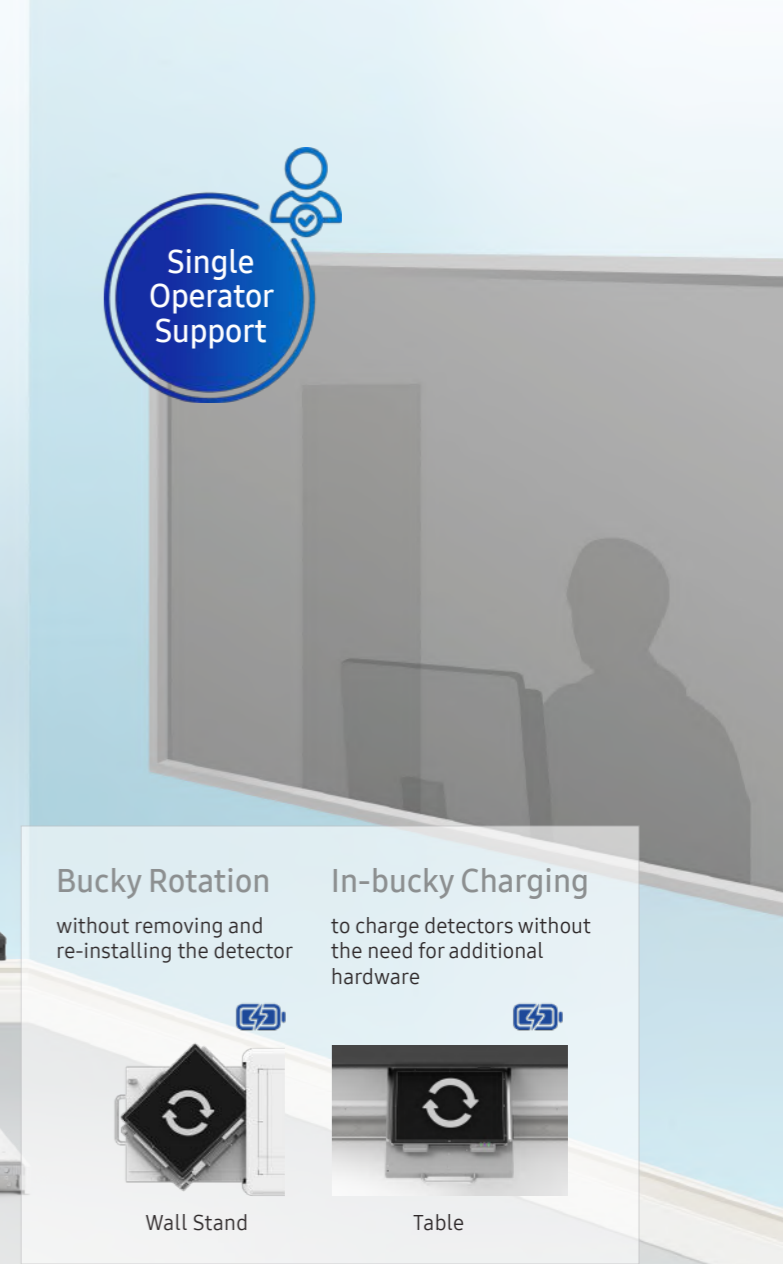
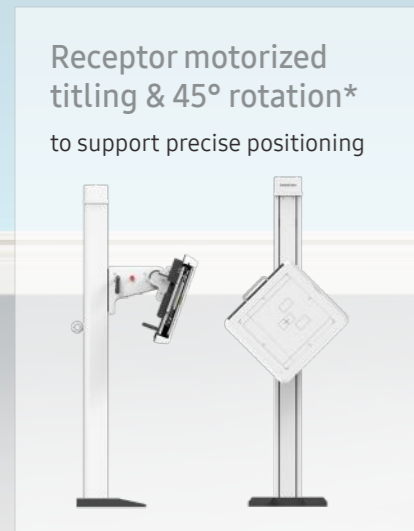
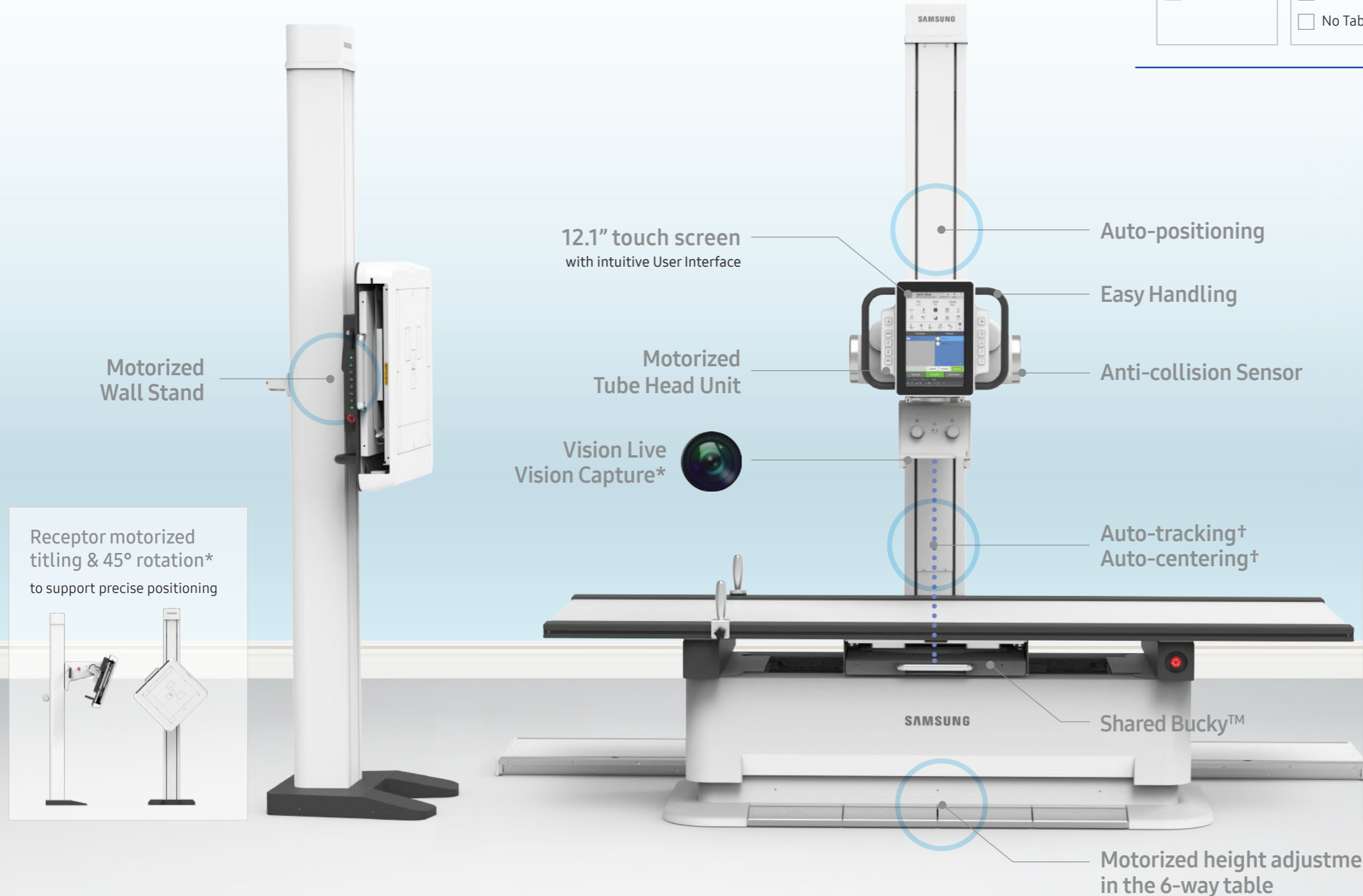

STREAMLINE WITHOUT COMPROMISE

Auto-positioning

Auto-positioning allows the system to move to pre-programmed exam positions with a single click. This feature provides effortless control and simplifies daily routines.



Auto-centering†

For a seamless workflow, Auto-centering automatically aligns the tube head unit to the center of the detector at either the table or wall stand.

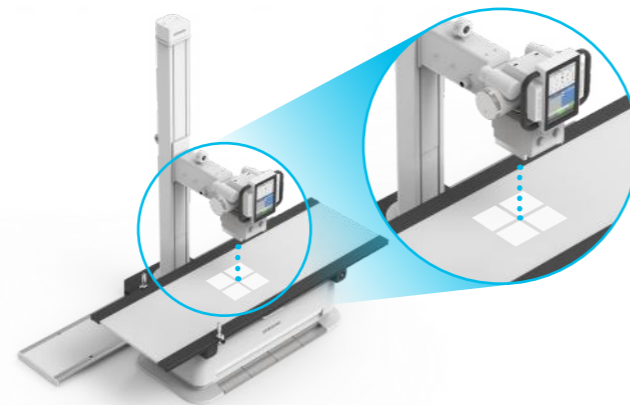

Auto-tracking†

Auto-tracking automatically synchronizes the movement of the tube and detector to reduce repetitive tasks.

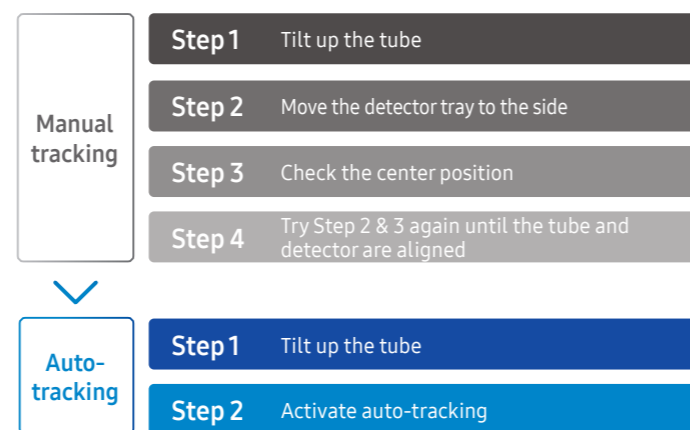

Shared Bucky™

Shared Bucky™ is designed for sharing two sizes of detectors in one bucky tray in the table. (F4335-AW, S4335-AW, S4343-AW)

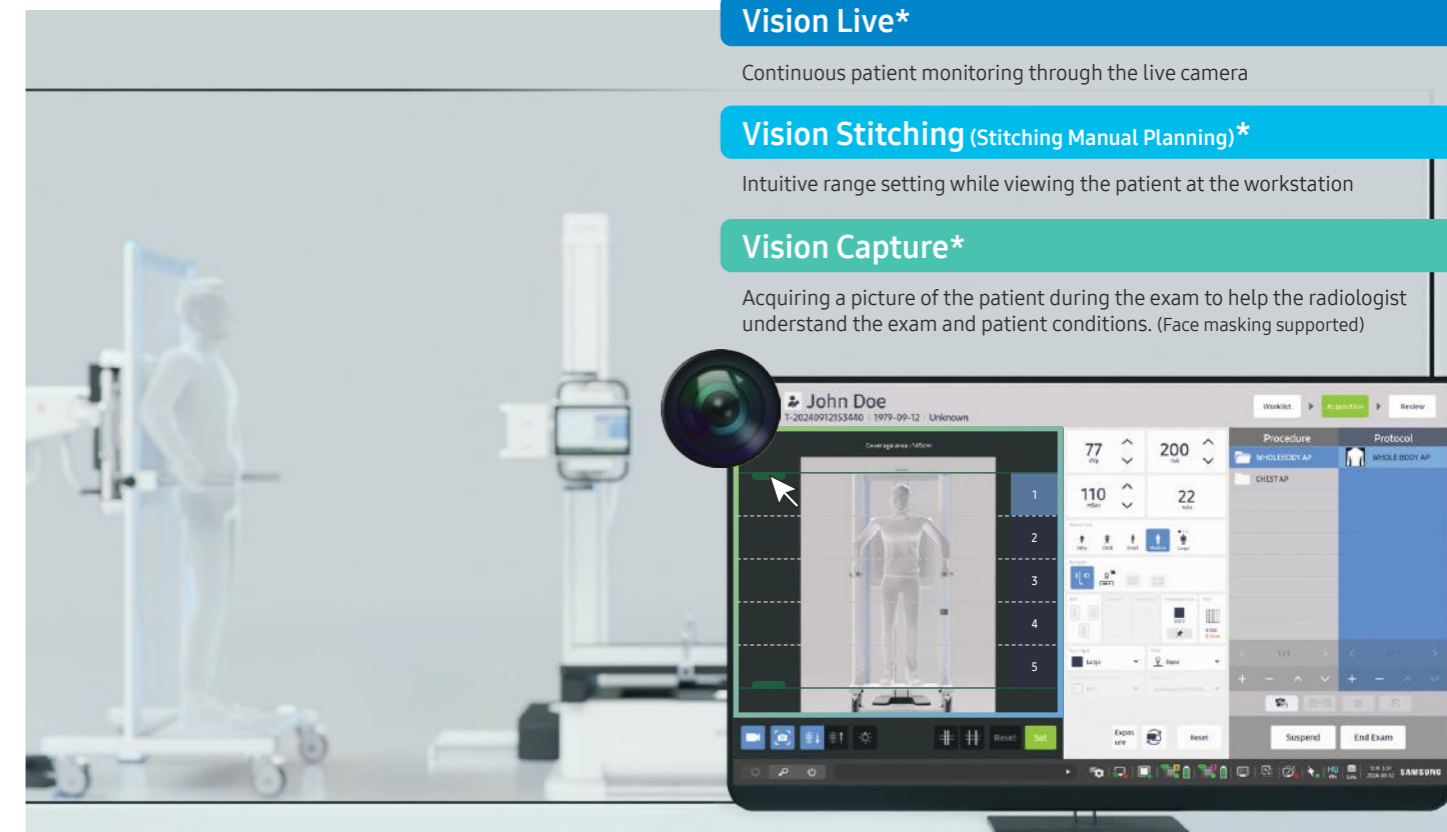
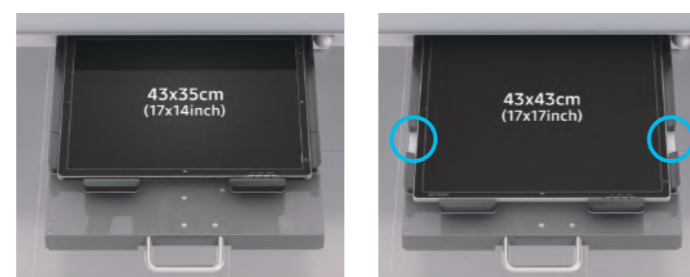

Vision Live*

Continuous patient monitoring through the live camera

Vision Stitching (Stitching Manual Planning)*

Intuitive range setting while viewing the patient at the workstation

Vision Capture*

Acquiring a picture of the patient during the exam to help the radiologist understand the exam and patient conditions. (Face masking supported)

Exhaustive Quality Control

A lot of test categories are performed to find and analyze any defects that may affect the system. We conduct internal tests comparable to international testing standards such as MIL-STD, ASTM, IEC, and etc.

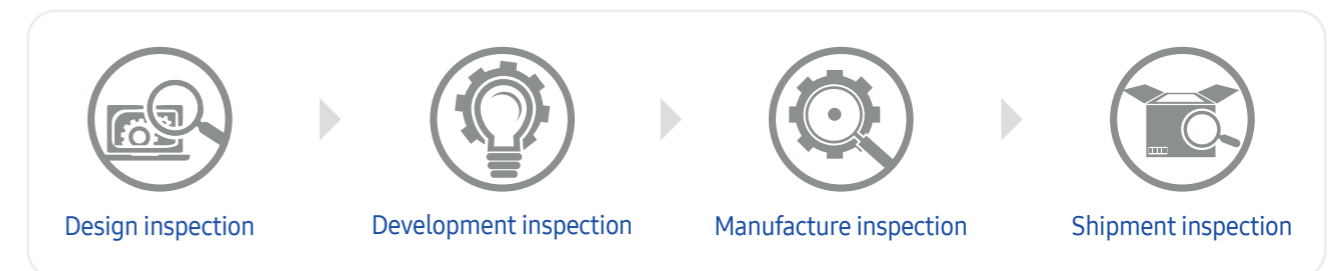

Reliability test

Samsung systems undergo strict reliability and durability tests to provide consistent imaging quality and performance.

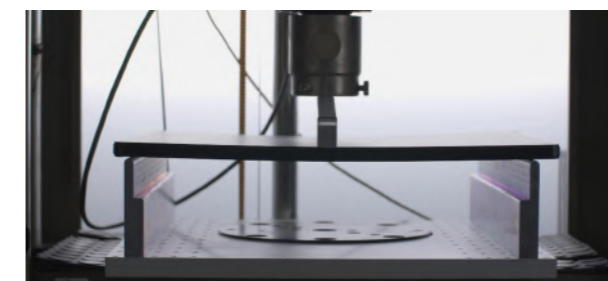

Life span management

Based on the user scenario, the tests are divided into electronic and mechanical aspects to carefully perform component stress assessment and operational endurance testing.

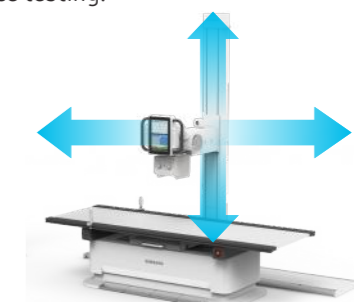

STREAMLINE WITHOUT COMPROMISE

27% Lighter† ACC Glass-Free Detector

The AccE Glass-Free Detector offers a more comfortable imaging experience. It is designed to relieve user fatigue by replacing a glass-based substrate with a lightweight, non-glass flexible panel. This glass-free technology not only makes it 27% lighter†, but also does not compromise the image quality with high DQE (76% @0lp/mm).

Lightweight approx. **2 kg‡** (4.5 lbs)



Reliable in Versatile Environment

Impressive load allowance along with dust and water resistance enables the detector to be actively implemented in versatile environments. The robust design allows for the reduction in user concern when performing exams in an OR and ER setting.

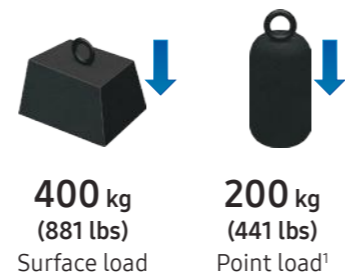

Enhance Your Daily Workflow

The user-centric design aids in efficiency and portability, alleviating daily burdens.

- CENTER ENGRAVING** to help position the patient
- REAR GRIP** to support transportation
- SIDE CHAMFER** to ease your lifting



Manage Your Detector Wisely

Continuous status tracking of the detector will enhance user confidence and improve the system's uptime. Features such as real-time shock sensing and detector auto correction will allow the detector to be in shape for use and help you respond quickly to critical detector shocks.

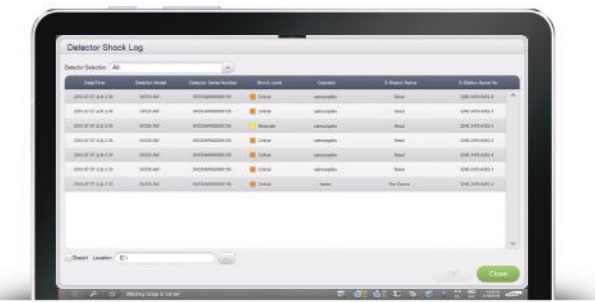

Real-time Shock Sensing

Voice Guide*

For radiologic technologists, it can be a burden to repeat the same comments to each patient, such as breath in/hold, do not move, etc. With exposure switch or hotkey control (F1~F8), you can conveniently deliver pre-recorded comments and it also helps to alleviate language barriers with foreign-language speaking patients.



Virtual Remote Controller*

With the virtual controller, users can control the tube head unit or table through the screen in the control room. There is no need to spend time looking for a remote control.

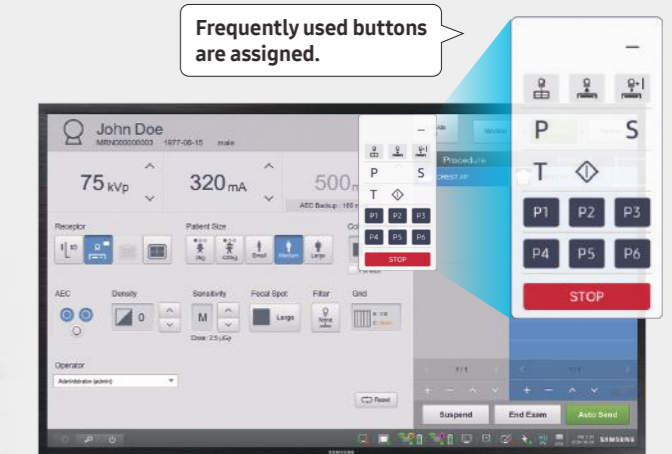

† Compared to S4335-AW without battery set
‡ Measured without battery set
1) Based on 40 mm diameter disc at the center

DIAGNOSTIC CONFIDENCE

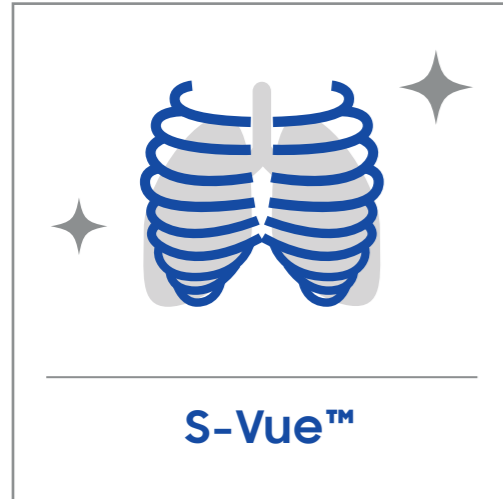

S-Vue™

S-Vue™ image processing engine provides excellent, high resolution images for diagnostic accuracy and confidence. Its anatomy adaptive enhancing and noise reduction technologies offer outstanding sharpness and readability.



Consistent Image Quality



Enhanced Anatomical Clarity

Case 1. Chest AP (X-Large adult)



The image was taken with GM85.

Case 2. Abdomen



These images were taken with GC85A.

Case 3. L-spine



Case 4. Pelvis (Halo artifact)



The image was taken with GC85A.

The upgraded S-Vue™ displays areas with varying bone density clearly, regardless of the patient's size or body region through advanced region-specialized processing.



Low Dose in New S-Vue™

S-Vue™ not only provides excellence in image quality, but also secures better patient safety in radiography examinations. This can help change the patient's perspectives for X-ray radiation and improve patient satisfaction.



Our Pledge for Low Dose

Samsung's Low Dose campaign is going to change your ordinary X-ray experience into our low dose imaging experience. Our commitment to lower dose will help you give more care to the ones you love. We will accompany with you as a lifetime partner in the right way.

Case. Pediatric Chest PA¹

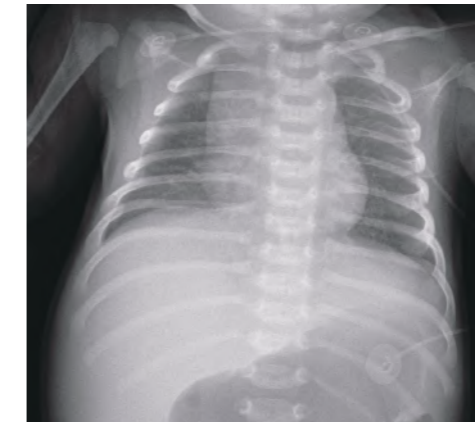

Conventional

16.1 uGy

(54 kVp / 1.42 mAs / 0.06 dGy*cm² / 0.1 mmCu Filter)

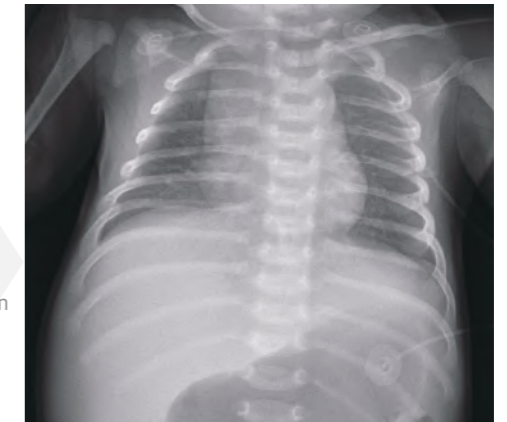

Low Dose

13.7 uGy

(54 kVp / 1.21 mAs / 0.05 dGy*cm² / 0.1 mmCu Filter)

15%
Dose Reduction

Images were taken with GM85.

Precise dose management features

* Optional feature requiring additional purchase



Automatically optimized dose controls prevent excessive radiation exposure and provide precise dose control for patients.

- 6-stage Pediatric Exposure Management according to weight
- Bariatric Exposure Management* (X-Large/2X-Large)
- Automatic filter with APR
- Individual blade control
- Dose Report
- AEC



¹Note: The claim concerning Samsung DR is based on limited phantom and clinical study results. Only routine PA chest radiography and abdominal radiography for average adults and pediatric abdominal, chest, skull radiography were studied, excluding pediatric patients under 1 month old. (FDA cleared - K172229, K180543, K182183) In practice, the values of dose reduction may vary accordingly. These clinical images calculate the dose reduction rate from its own standard dose at the clinical site, unlike our FDA claim which compares dose between new IPE and old IPE. The clinical site is responsible for determining whether the particular radiographic imaging needs are not impacted by such x-ray dose reduction.

DIAGNOSTIC CONFIDENCE

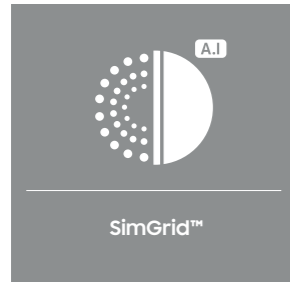

SimGrid™*

With just a click, SimGrid™ allows you to provide better patient care with higher satisfaction and reduced retake rates without the use of a portable grid. It improves image contrast by reducing scatter radiation effects and creates better image quality. The 3-step intensity control (Low/Medium/High) enables customized image processing.

Case. Chest AP

Images were taken with GM85.



Without Grid



With SimGrid™



S-Enhance*

To support your diagnosis, S-Enhance improves the clarity of foreign bodies (e.g. tube, line and/or needle) in images of chest, abdomen, and L-spine. With a single on-screen click, the companion image is created without additional settings or x-ray exposure, streamlining the workflow.

Case. Chest AP

Images were taken with GM85.



Without S-Enhance



With S-Enhance

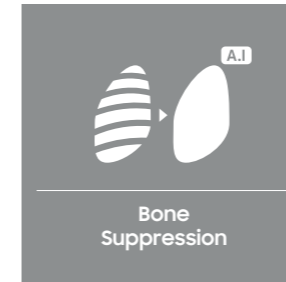

Bone Suppression*

Without additional setting or exposure, Bone Suppression imaging improves the clarity of soft tissues by suppressing the appearance of bones in chest images, which enhances your ability to detect nodules. You can easily create the companion image with just a click on the screen.

Case. Chest PA

Images were taken with GC85A.



Without Bone Suppression

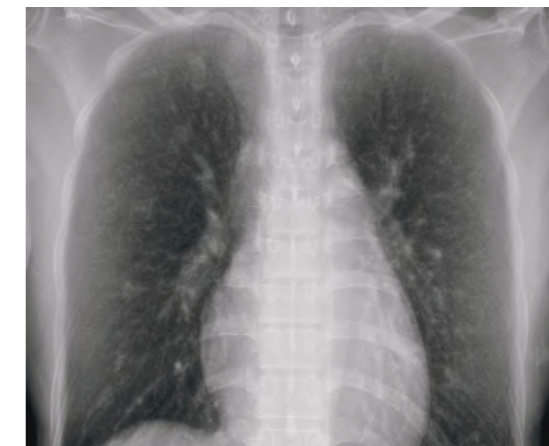

With Bone Suppression

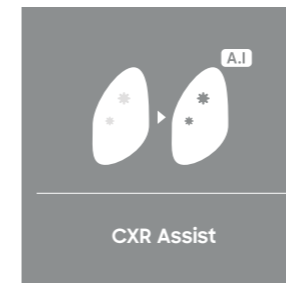

CXR Assist*

CXR Assist with Lunit INSIGHT CXR Triage (FDA cleared K211733) analyzes adult chest X ray images for the presence of pre specified suspected critical findings (Pleural effusion and/or Pneumothorax). Seamlessly connected to the PACS workstation, this feature prioritizes exams for the radiologists, enabling timely treatment of critical or urgent patients and improving overall efficiency.

AI Results		ID	Age	Time
Pef	Ptx			
●		18291CCEE	18	10:50 AM
	●	23075CCEE	63	12:15 PM
		29110CCEE	26	10:12 AM
		31291CCEE	33	10:21 AM
		11007CCEE	43	10:36 AM



S-Station/PACS Worklist Prioritization

This PACS worklist is intended to help healthcare professionals understand the functions of this product. Please note that this worklist may differ from the actual product.

EXPAND PREMIUM EXPERIENCE

Samsung Platform

Our reliability and stable services are the result of continuous upgrades based on extensive customer feedback. Experience an integrated DR solution for efficient and successful hospital operations.

Intuitive UI/UX · SMART Center · S-Share™ · Cybersecurity · QAP · Value care service



Standardized management with SMART Center*

S-Share™

S-Share™ can dramatically increase efficiency through the use of AccE Glass-Free Detector, AccE Detector, and AccE Standard Detector with various existing compatible equipment. It enables accelerating connection for better synergy of Samsung DR systems.



GC85A Vision+ is a sub-configuration of GC85A with upgraded Vision Assist.

Samsung DR Cybersecurity



Samsung's Defense-in-depth

· Designed holistic protection for your critical assets with multi-layered security controls: physical, operating system hardening, network, access control, application, and data layers

World-class Management System





· Received independent certification including ISO/IEC27001, SO/IEC27701
· Comply with Risk Management Framework (RMF) according to NIST SP 800-53

QAP*

QAP (Quality Assurance Program) assures consistent imaging performance in a precise and cost-effective way. It enables comprehensive system management by automatic periodic test measuring multiple parameters such as source performance, AEC accuracy, geometry accuracy, and detector performance with image quality.



Value care service

- 
Remote Software Update
 Keep the software up to date without service requests. The latest version of the software is notified for users to download and update.
- 
Remote Maintenance System
 This RMS continuously monitors any system errors and automatically identifies the system and software version.
- 
24/7 call center
 Our customer support center operates 24 hours per day, 365 days a year to quickly respond to any questions or problems you may have.
- 
Service offering
 Samsung provides tailored service and support programs to meet your unique requirements.

Maintenance service availability may vary by country.

About Samsung Electronics Co., Ltd.

Samsung Electronics Co., Ltd. inspires the world and shapes the future with transformative ideas and technologies.

The company is redefining the worlds of TVs, smartphones, wearable devices, tablets, cameras, digital appliances, medical equipment, network systems, and semiconductor and LED solutions. For the latest news, please visit the Samsung Newsroom at news.samsung.com.

GF85 Catalog v1.0-241113-FDA



Scan code or visit
www.samsunghealthcare.com
to learn more



Associated X-Ray Imaging Corp.
49 Newark Street
Haverhill, MA 01832

Toll Free: 800-356-3388
Phone: 978-374-6371
Fax: 978-521-2214

www.associatedxray.com
sales@associatedxray.com

Copyright © 2024 Samsung Electronics Co. Ltd. All rights reserved. Samsung is a registered trademark of Samsung Electronics Co. Ltd. Specifications and designs are subject to change without notice. Non-metric weights and measurements are approximate. All data were deemed correct at time of creation. Samsung is not liable for errors or omissions. All brand, product, service names and logos are trademarks and/or registered trademarks of their respective owners and are hereby recognized and acknowledged. Samsung Electronics Co., Ltd.

129, Samsung-ro, Yeongtong-gu, Suwon-si, Gyeonggi-do, 16677, Republic of Korea